

ESSENCE[®]

Essence is the crowd favorite for creating a more comfortable and attractive space. Designed for power, versatility, and sophistication, its performance transforms stuffy conditions and offers any setting a centerpiece of style. Quiet and efficient, Essence lets you provide an enjoyable experience that keeps employees motivated, customers engaged, and guests in awe of your space.



KEY FEATURES

- ▶ **Eight anodized airfoils** with winglets and safety restraints
- ▶ **Virtually silent** gearless direct-drive motor
- ▶ **Lightweight design** mounts to bar joists, beams, purlins, and wood frames
- ▶ **Variety of control options** for convenience and efficiency
- ▶ **Indoor and outdoor** models available to fit any space
- ▶ **Color customization** and integrated LED kit available to optimize your style

DIAMETER

8-14 FEET
(2.4-4.3 METERS)

MOUNTING

**I-BEAMS, BAR JOISTS,
SOLID BEAMS, AND PURLINS**

CONTROL

**VARIABLE-SPEED
WIRED/WIRELESS
WALL MOUNT**

WARRANTY

UP TO
10 YEARS
MECHANICAL

UP TO
10 YEARS
ELECTRICAL



BIG ASS FANS[™]

**EXCEPTIONALLY
ENGINEERED**

**DISCOVER MORE
ABOUT ESSENCE**

Learn more at bigassfans.com/essence
or call **877.BIG.FANS** for a free custom quote.

ESSENCE

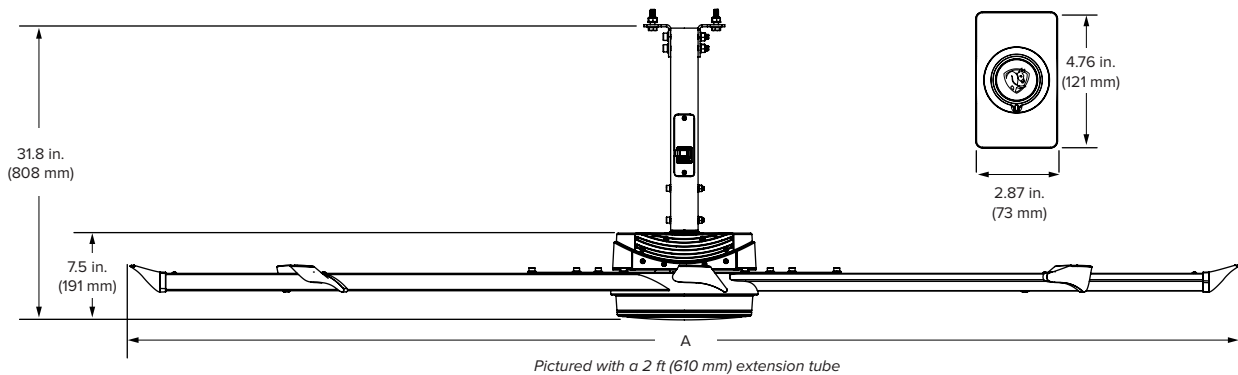
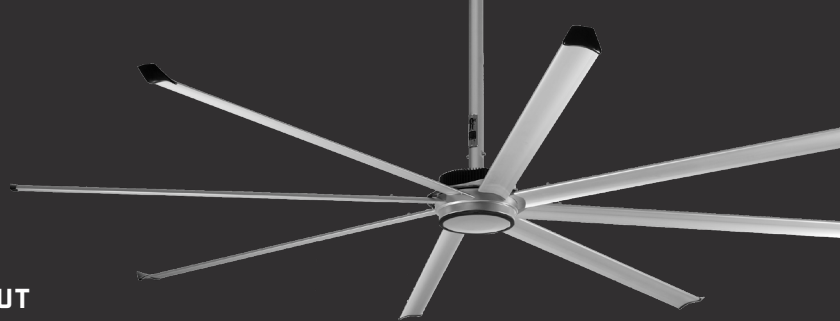

THE BEST FAN FOR A BIG SPACE, INDOORS OR OUT



Technical Specifications

Diameter (A)	Weight ¹	Max Speed	Input Power and Required Breaker	Airfoil Clearances ²	Sound at Max Speed ³	IP Rating	Max Operating Temperature	Environment ⁴
8 ft (2.4 m)	75 lb (34 kg)	158 RPM	110–125 VAC, 1 Φ, 50/60 Hz, 10 A 200–240 VAC, 1 Φ, 50/60 Hz, 10 A	2 ft (0.6 m) on sides 2 ft (0.6 m) below ceiling deck	< 35 dBA	IP43	-4°F to 131°F (-20°C to 55°C)	Suitable for indoor or outdoor spaces
10 ft (3 m)	81 lb (37 kg)	107 RPM						
12 ft (3.7 m)	88 lb (40 kg)	76 RPM						
14 ft (4.3 m)	96 lb (44 kg)	56 RPM						

Construction Features

Airfoils	Motor and Drive	Certifications ⁵	Mounting	Accessories	Colors
Eight anodized Mini-Ellipto airfoils with winglets (black or silver)	Gearless direct drive motor	 <ul style="list-style-type: none"> UL Standard 507 and CSA Standard 22.2 No. 113 	Standard upper mount installs to bar joists Optional kits allow for mounting to I-beams, solid beams, and purlins	LED Light Wireless Wall Controller	Standard colors are silver and black. Individualize your fan with one of our classic color upgrades, or work with our design consultants to create a shade that's all your own.

Standard Color Options

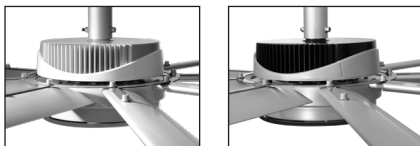

White Motor Housing with Silver Trim

Silver Motor Housing with Black Trim

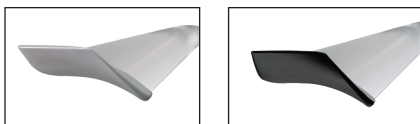

LED Light (Optional)

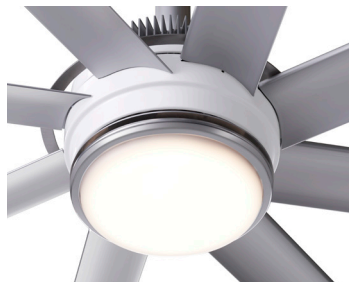

See the Essence LED spec sheet for details.

Control Options



Wired Wall Controller



Remote With Wall Mount (Optional)

¹ Weight does not include mount or extension tube.
² Suitable for ceilings as low as 12 ft (3.7 meters). Measure the distance from the tip of the winglet to the ceiling or major obstruction.
³ Fans are sound tested at maximum speed in a laboratory environment. Actual results in field conditions may vary due to sound reflecting surfaces and environmental conditions.
⁴ Not suitable for salt air environments.
⁵ Certifications listed here apply to the fan and do not include accessories.

Lead times may vary. See full warranty for coverage information.