

AIRGO[®]

When you need maximum airflow on the move, you need AirGo. Featuring Big Ass Fans' patented HVLS technology in durable, portable frame, it delivers targeted airflow on a massive scale. Simply dial in the exact level of cooling you need and let AirGo improve conditions on the factory floor, in the service bay, or on the sidelines.

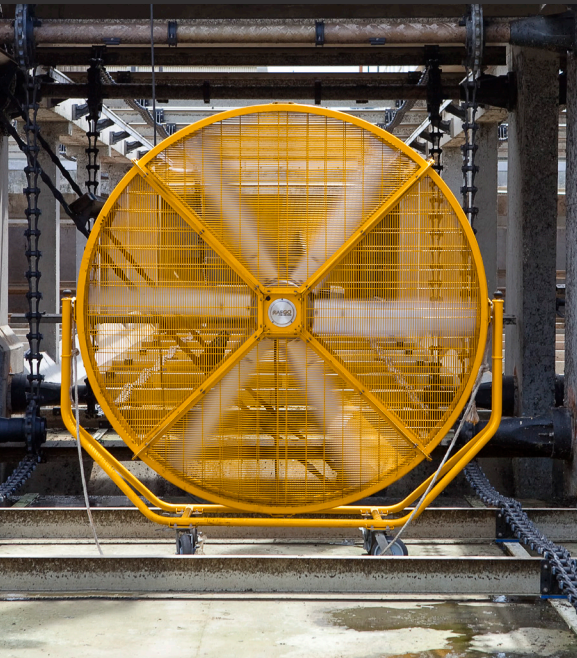

KEY FEATURES

- ▶ **Six aluminum airfoils** with winglets in an OSHA-compliant cage
- ▶ **Quiet, efficient EC motor** with variable speed control
- ▶ **Full 360° tilt** with 16 lockable positions
- ▶ **Locking swivel casters** allow for optimal maneuverability
- ▶ **Powerful airflow** provides coverage up to 120 feet (37 meters) away
- ▶ **Indoor or outdoor** operation for cooling that goes anywhere

DIAMETER

8 FEET
(2.4 METERS)

FRAME

**OSHA-COMPLIANT
STEEL CAGE ON CASTERS**

VOLTAGE

**110-125 OR 200-240
SINGLE PHASE VAC**

WARRANTY

**UP TO
5 YEARS**



BIG ASS FANS[™]

**EXCEPTIONALLY
ENGINEERED**

**DISCOVER MORE
ABOUT AIRGO**

Learn more at bigassfans.com/airgo
or call **877.BIG.FANS** for a free custom quote.

AIRGO

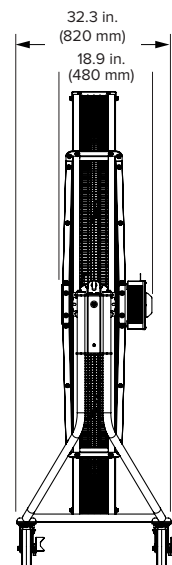
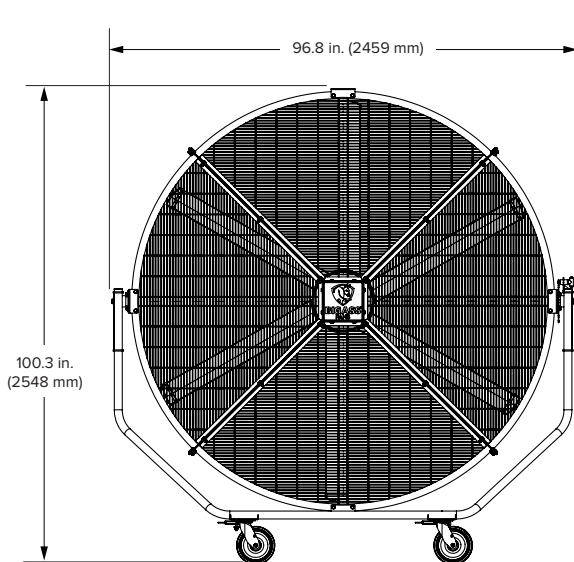
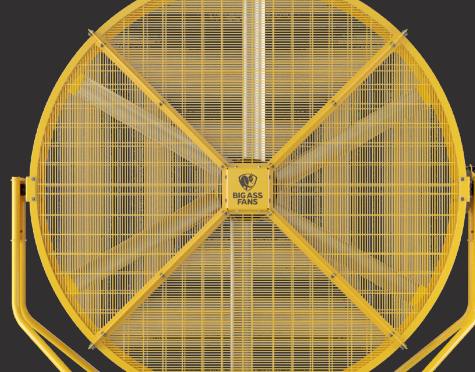

AIR. ON THE GO. NOW!



Technical Specifications

Input power and required breaker	Amperage	Wattage	Operating Temperature	Sound at max speed ¹	Weight
110–125 VAC, 50/60 Hz, 1 Φ, 15 A	7.7–7.0 A	481 W	-4°F to 131°F (-20°C to 55°C)	64 dBA	425 lb (193 kg)
200–240 VAC, 50/60 Hz, 1 Φ, 10 A	5.6–4.7 A	469 W			

Construction Features

Cage and Frame	Motor and Controller	Power Supply	Environment ²	Certifications	Colors	Accessories
Preassembled 8 ft (2.4 m) steel frame OSHA-compliant cage	Direct drive ECM motor Variable speed control	25 ft (7.6 m) cord with plug fits standard power outlet Optional 10 ft (3 m) cord available	IPX5 for indoor or outdoor use Washdown construction	 UL Standard 507 and CSA Standard 22.2 No. 113 	Yellow or white Custom colors available	Protective cover

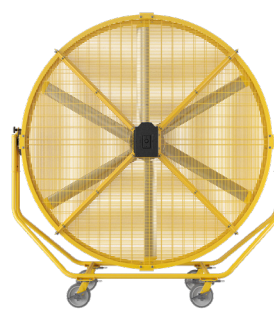
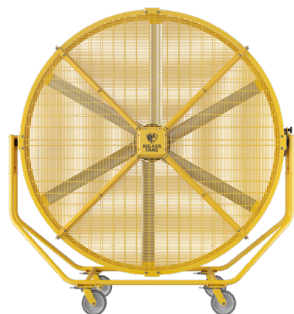

¹ Fans are sound tested at maximum speed in a laboratory environment. Actual results in field conditions may vary due to sound reflecting surfaces and environmental conditions.
² Not suitable for salt air environments. Do not leave fan outdoors for extended periods of time or in anticipation of inclement weather.

Lead times may vary. See full warranty for coverage information.



USA
BIGASSFANS.COM
877-244-3267

CANADA
BIGASSFANS.COM
844-924-4277

AUSTRALIA
BIGASSFANS.COM/AU
1300 244 277

SINGAPORE
BIGASSFANS.COM/SG
65 6709 8500

AIRGO

AIRFLOW

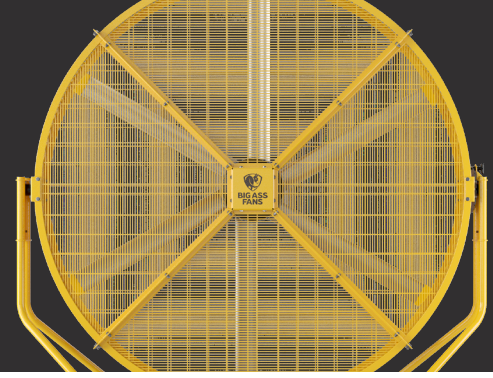

AIRFLOW VELOCITY

The three lines show air velocity from the center of the fan at three sensors of varying height.

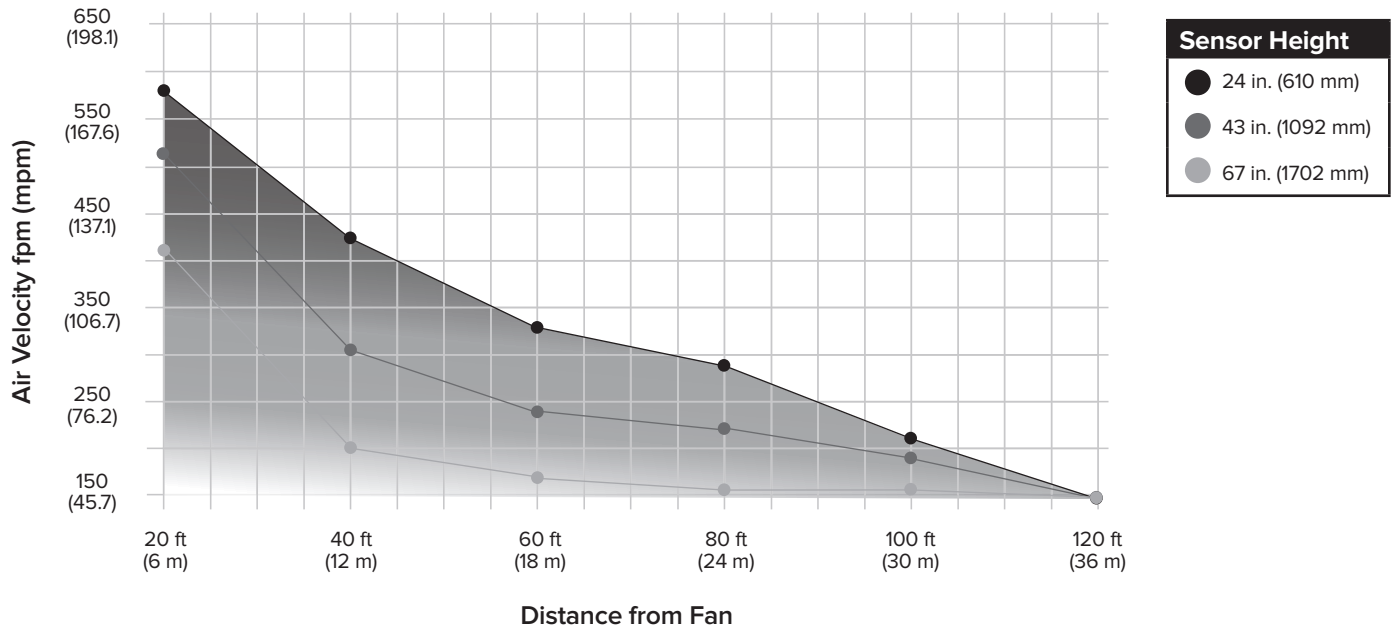

AIRFLOW DISTANCE

Shaded areas represent cooling up to 120 feet (36.6 meters). That's one-third the length of a football field! Darker shading indicates faster air velocity.

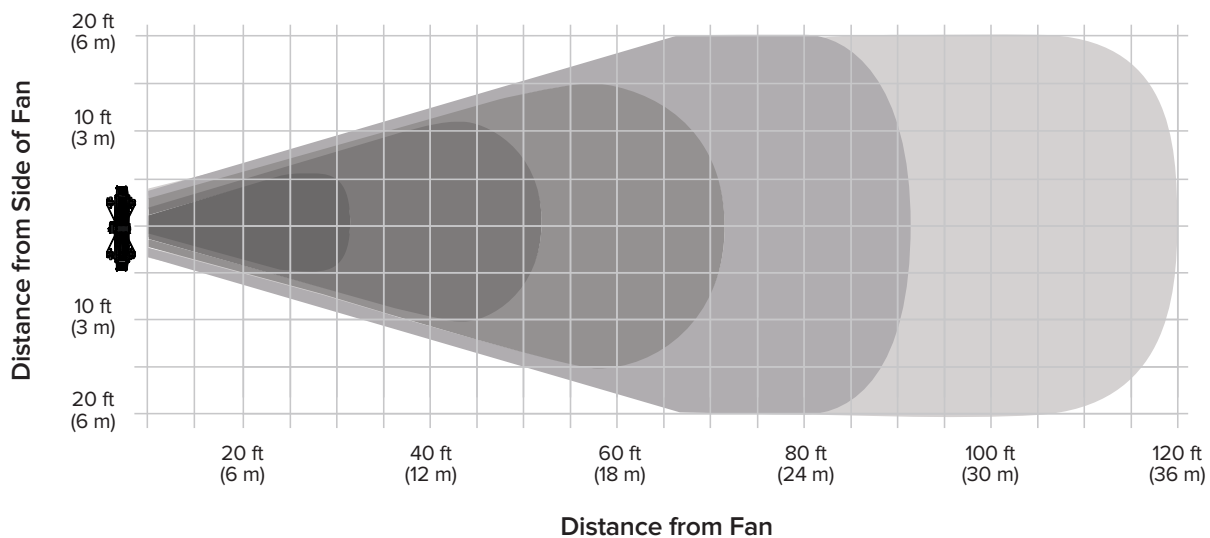

USA
BIGASSFANS.COM
877-244-3267

CANADA
BIGASSFANS.COM
844-924-4277

AUSTRALIA
BIGASSFANS.COM/AU
1300 244 277

SINGAPORE
BIGASSFANS.COM/SG
65 6709 8500